

# How to Order

# How to Request a Quote

Please provide answers to the questions below to expedite the process of preparing a quote. To reach one of our sales teams with any questions please contact your regional Light Tape® distributor at [www.lighttape.com/contact](http://www.lighttape.com/contact)

Contact Information:	Name; Company; Email; Phone; City; Country
Application Type	Accent Lighting, Backlighting Surfaces, Branding, Outdoor Advertising, Safety Guidance Systems, Theatre Lighting Systems, Other
Indicate location:	Interior or Exterior, Wet area, Wall/Floor, Short Term or Long Term
Indicate required input power source:	(i.e AC or DC)
Indicate the number of Circuits:	(i.e 3 strips, 2 Circuits) refer to page C3 and C4
Specified width(s) (custom widths and shapes are available):	The total width of the lamp required. Please note, lamination border will need to be taken into considerations. Refer to pages A6 and C5
Specified quantity and length(s):	The total length of the lamp required. Please note, lamination border and connector will need to be taken into consideration. Refer to A6 and B5.
Indicate color preference(s):	Refer to page A8
Provide a top view drawing of your lighting layout indicating dimensions of the Light Tape® and power source locations:	Refer to pages C3 and C4.
Indicate mounting preferences. For adhesive tape or Velcro, indicate if you would like either to be preinstalled prior to arrival for an additional fee:	(i.e Double-sided adhesive, Velcro, extrusion channels) Refer to page D6.
Connector preference:	i.e standard or low profile (Refer to page B5), please indicate if extended tab is required. The average length from end of panel to beginning of connector on extended tab is 80mm.
Describe the purpose of the project and other things space or of creative inspiration) we should consider:	(A description of the design concept and photos of the space or of creative inspiration)

# Accent Lighting Example: Top View

## MULTI-POWER SUPPLY INSTALLATION

A top view example of a Light Tape® interior accent lighting installation. Note there are three segments of Light Tape® powered by three individual power supplies. Each power supply is selected based on the total surface area.

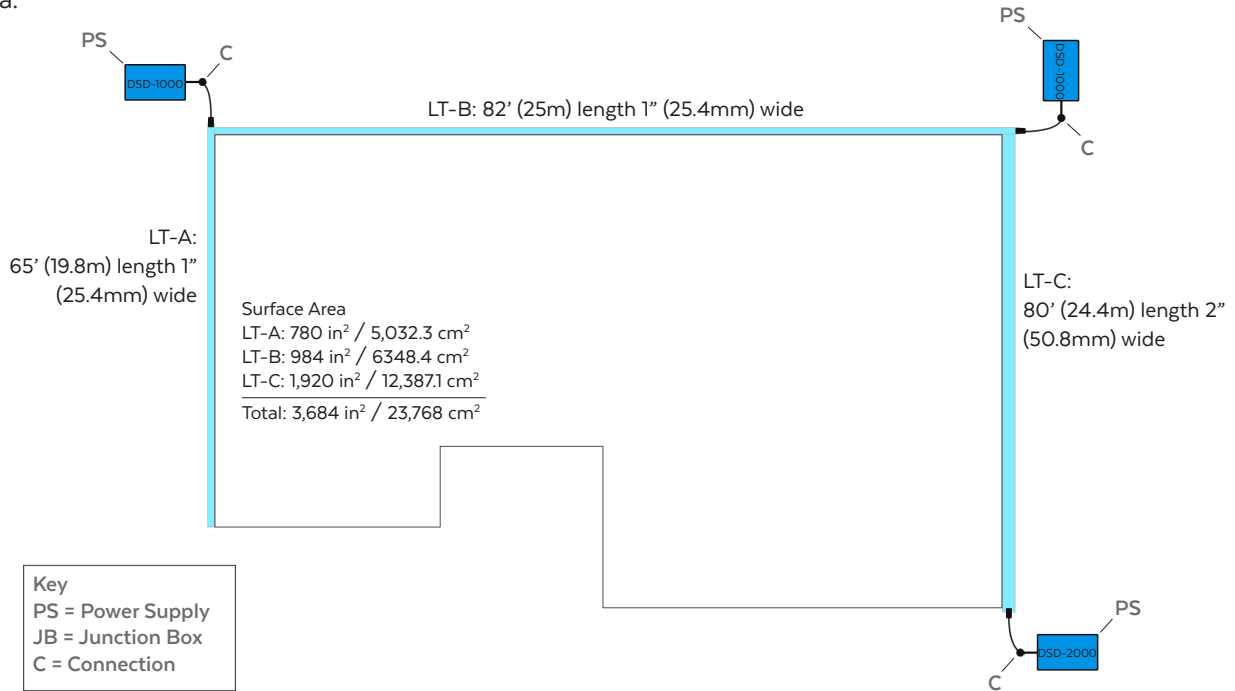

## SINGLE POWER SUPPLY INSTALLATION

Now a top view of the same Light Tape® installation as above. Note there are three segments of Light Tape® powered by one individual power supply. The power supply is selected based on the total surface area of the all the segments combined. Each Light Tape® segment is connected via junction box to the same power supply.

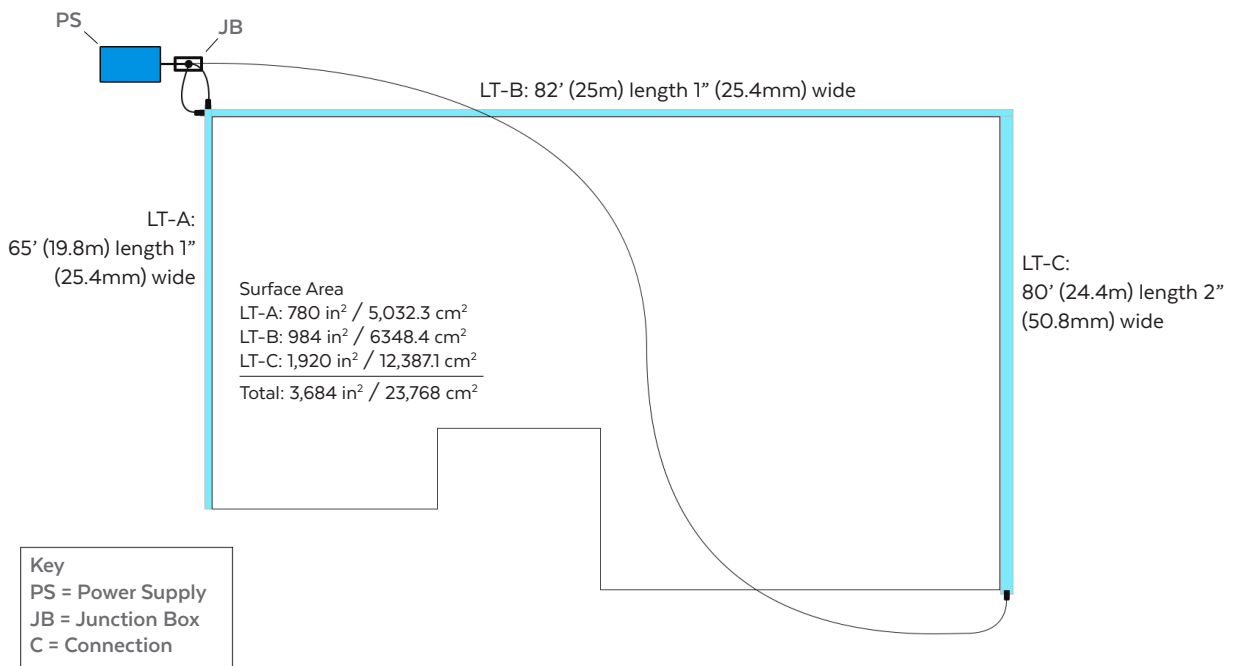

# Backlighting Materials: Top View

## BASIC BAR, COUNTER TOP OR WALL

Any surface area can be evenly illuminated with a minimal number of panels and connections. A bar design resembling the one below would require only two Light Tape® panels and one power supply. The Light Tape® panel is placed directly on surface with double sided adhesive.

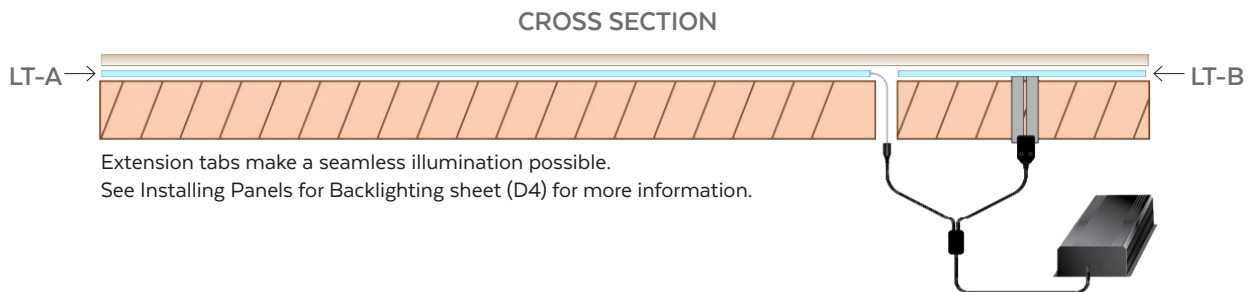
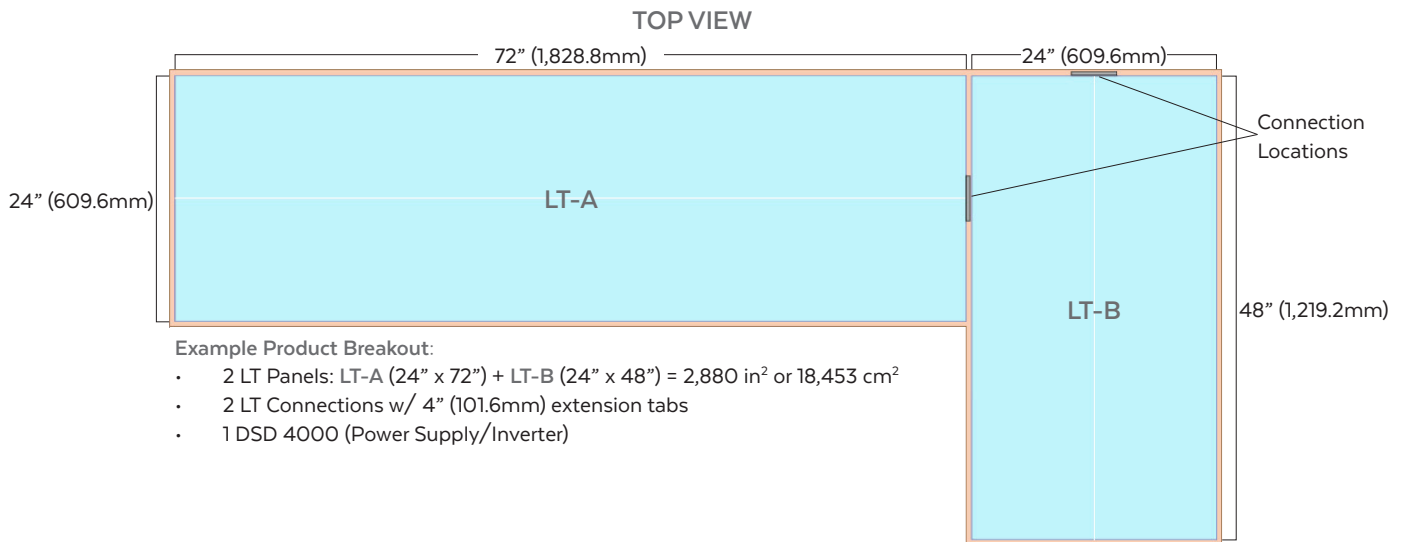

## SURFACE WITH CUT OUTS

Light Tape® panels can be custom cut to any shape and placed side-by-side or overlapped to seamlessly illuminate any surface. For custom shapes, an AI file or template will need to be provided.

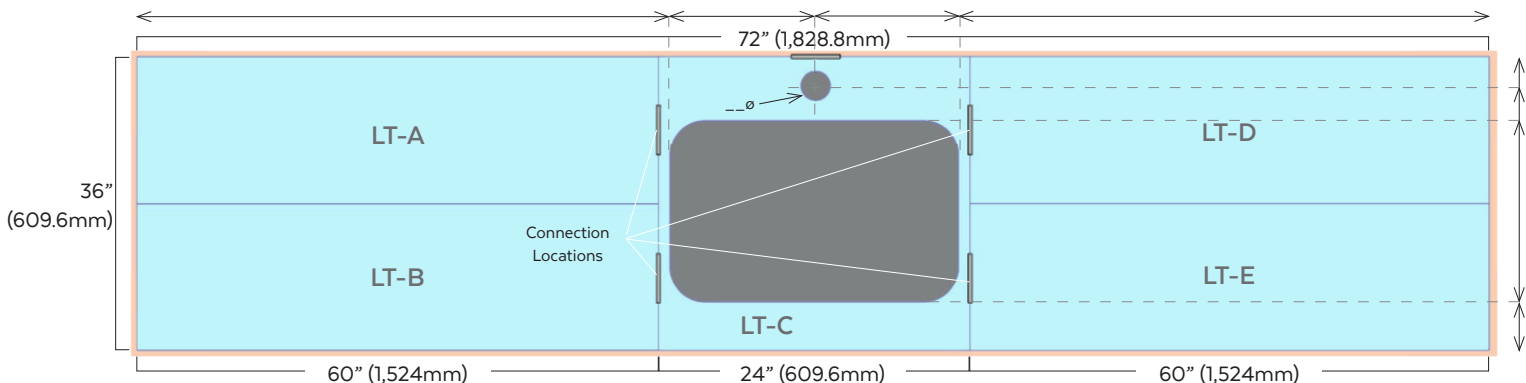

**Example Product Breakout:**

- 4 LT Panels: LT-A, LT-B, LT-C, LT-D (4)(18"x 60") = 4,320 in<sup>2</sup> or 27,871 cm<sup>2</sup>
- 1 LT Custom Panel LT-C (24"x 36") - (12"x24" cutout) = 576 in<sup>2</sup> or 3,716cm<sup>2</sup>
- 5 LT Connections w/ 4" (101.6mm) extension tabs
- 1 SD 8000 (total 4,896 in<sup>2</sup>)

Please note: accurate dimensions for cutouts are required for all custom cut panels

# Backlighting Custom Shapes

Light Tape® can be cut into just about any shape and size whilst maintaining its uniform illumination.

No shape is impossible to illuminate, regardless of the size. This makes Light Tape® the most versatile lamp in the world, suitable for any kind of bespoke design.

## SYMMETRICAL SHAPES

Both hemispheres need to be equal in surface area to ensure that Light Tape® illuminates evenly. Symmetrical shapes such as the one shown are easily produced, with the SEMP (split electrode midpoint) dividing the shape into two equal hemispheres.

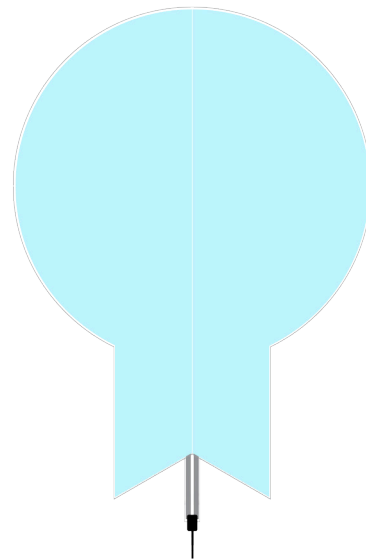

## ASYMMETRICAL SHAPES

Creating a custom shaped light source would usually be a daunting process, but with Light Tape®, bespoke lighting has never been easier. For Asymmetrical shapes, we require an Adobe illustrator or PDF file to be submitted with your design. From this file, we can determine the total surface area of your shape and place the SEMP so that the shape is divided into two equal hemispheres.

If you do not have an AI file for your shape, it is possible for our team to create one for you. In this case, simply provide a template of your shape, and we can do the rest.

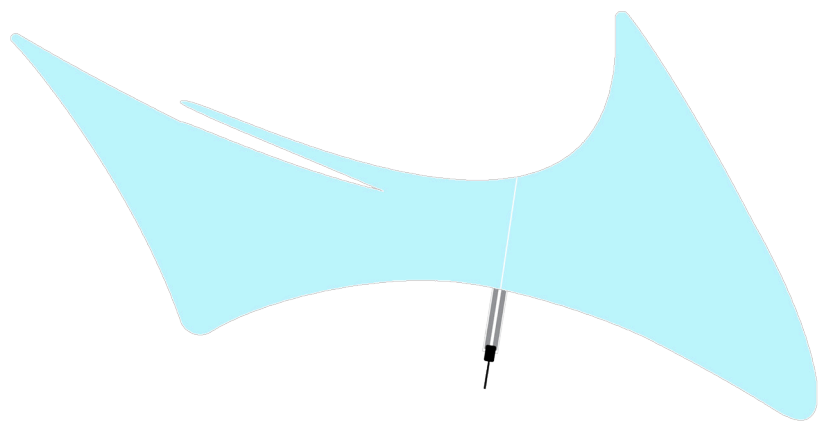

WWW.LIGHTTAPE.COM