

Backlighting Surfaces

United States (Headquarters)

1320 N. Boulevard
Richmond, VA 23230
Tel: 804 355 1692
thelighttapeteam@lighttape.com

Australia

27 Jones Street, O'Connor
Western Australia, 6163
Tel: (08) 9337 5217
australia@lighttape.com

Europe

Russell Conway
Business Development Leader
Tel: +44 7860 967410
europe@lighttape.com

India

75/6, Shipra Path, Mansarover
Jaipur (Rajasthan) INDIA
Tel: +91 9829056623
india@lighttape.com

South Africa

1st Ave East Parktown North
The Warehouse Unit 3, JHB 2193
Tel: 011 447 9709
southafrica@lighttape.com

South America

Cra. 5A No. 2Sur-45, CA12
Chia, Cundinamarca - Colombia, Sur
America
Tel: 313 819 2209
southamerica@lighttape.com

Turkey

Russell Conway
Business Development Leader
Tel: +44 7860 967410
europe@lighttape.com

Table of Contents

Backlighting Surfaces

- A6. Light Tape® Standard Sizes
- A8. Color Options
- C4. Backlighting Materials: Top View
- C5. Backlighting Custom Shapes
- D2. Light Tape® Safety & Handling
- D3. Indoor Installation
- D4. Installing Panels for Backlighting

Light Tape® Standard Sizes

Item No.	Illuminated Width		Laminated Width (Interior)		Laminated Width (Exterior)	
	Inches	Millimeters	Inches	Millimeters	Inches	Millimeters
LT-025	0.25"	6.35mm	0.5"	12.7mm	0.75"	19.05mm
LT-050	0.5"	12.7mm	0.75"	19.05mm	1"	25.4mm
LT-100	1"	25.4mm	1.25"	31.75mm	1.5"	38mm
LT-150	1.5"	38mm	1.75"	44.45mm	2"	50.8mm
LT-200	2"	50.8mm	2.25"	57.15mm	2.5"	63.5mm
LT-300	3"	76.2mm	3.25"	82.55mm	3.5"	88.9mm
LT-400	4"	101.6mm	4.25"	107.95mm	4.5"	114.3mm
LT-600	6"	152.4mm	6.25"	158.75mm	6.5"	165.1mm
LT-1200	12"	304.8mm	12.25"	311.15mm	12.5"	317.5mm
LT-1800	18"	457.2mm	18.25"	463.55mm	18.5"	469.9mm
LT-2400	24"	609.6mm	24.25"	615.95mm	24.5"	622.3mm
LT-3000	30"	762mm	30.25"	768.35mm	30.5"	774.7mm

Please note: Custom widths available to order

WHEN ORDERING, PLEASE SPECIFY:

- Installation location - Interior (INT) or Exterior (EXT)
- Desired illuminated color
- Illuminated width item number
- What length for each Light Tape® lamp? (min order length of 25 ft / 7.62m required)
- Total number of lamps required
- Power Input - AC or DC? What input voltage?
- Flexible extension connection tabs for backlighting applications are standard at 4" long. This allows connector to be hidden. Please advise if longer lengths are required.

TOP VIEW

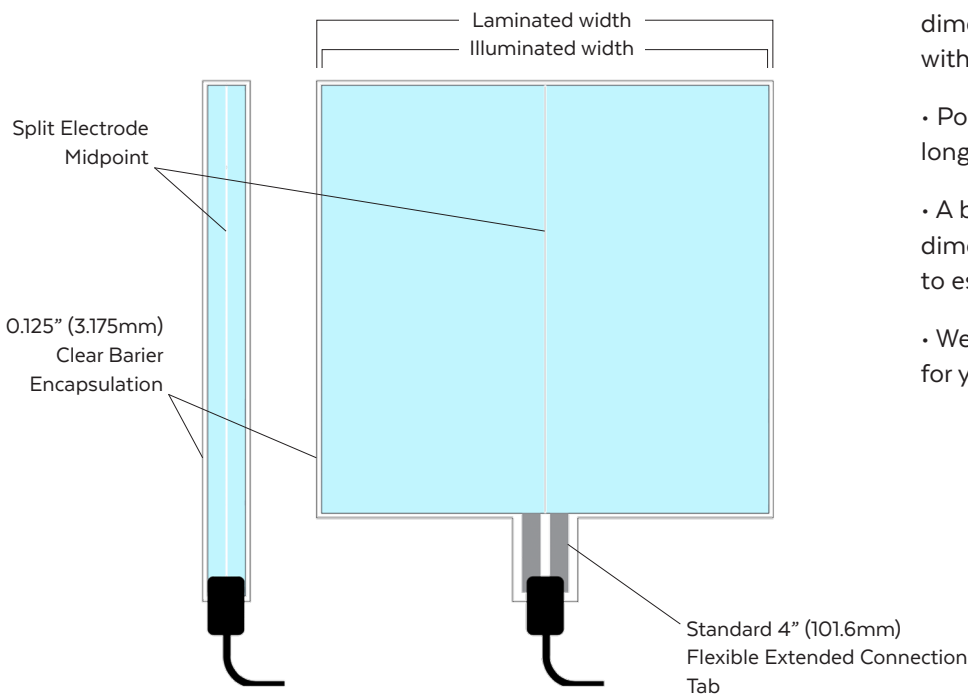

ADDITIONAL INFORMATION:

- Custom widths are possible to fit any dimensions. Light Tape® can be tiled together with no seams or gaps in illumination.
- Power input location (please specify short or long side of lamp).
- A basic top or front view drawing with dimensions is helpful to our engineering team to estimate materials needed.
- We will suggest best electrical configurations for your project based on site layout.

NOTE: the split electrode midpoint (SEMP) is a critical element of Light Tape®'s engineering that runs centered through the entire length.

Light Tape® Color Options

Our base colors are the Classic Natural Blue and Extreme Blue-Green. These colors appear white when off and lightly colored when illuminated. We then add filters to produce alternative color options.

Our Media White and Glacier White colors are perfect for backlighting and applications requiring white, unfiltered light, these will appear lightly colored when switched off.

Our remaining range of colors will retain their vibrance when not illuminated so you don't lose the desired effect even when it's switched off, perfect for branding and advertising.

CLASSIC SERIES



EXTREME SERIES

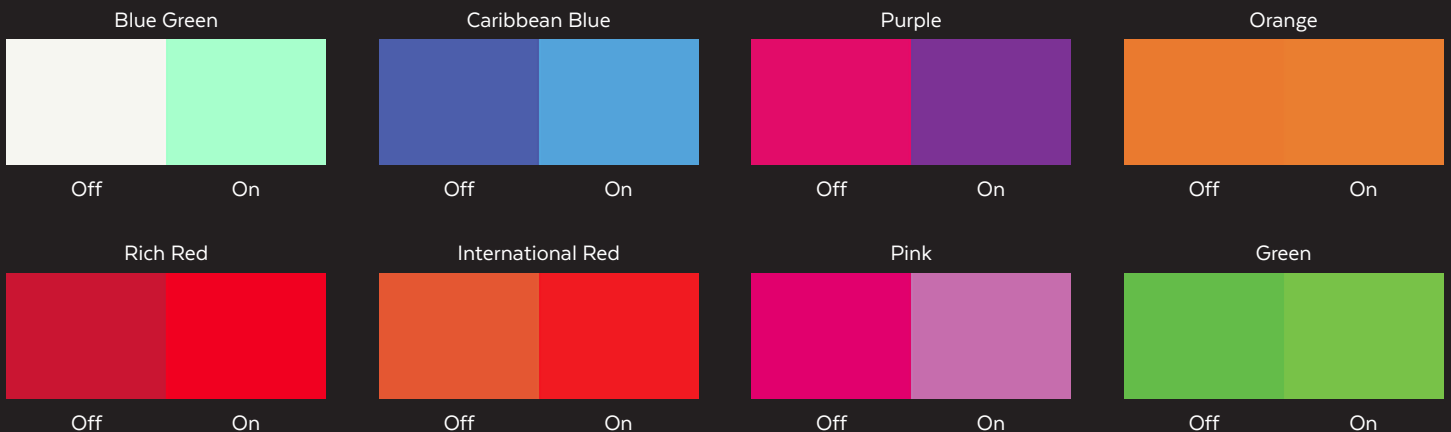

NOTE: The colors in this guide are simulated and as such the final product may vary. If an exact color is required, we recommend seeing a physical sample of the lamp. Custom colors and widths are available, but may be subject to minimum order quantities, set-up fees, and approval testing.

Light Tape® Safety & Handling

Safety:

- Never power on and leave Light Tape® in a coil. Unroll first before switching on.
- Always consult local electrical codes for wiring regulations and installation requirements.
- Light Tape® should be covered with a protective overlay if installed within direct reach of the general public.
- Always seal Light Tape® lamp with Edge Guard™ end seal tape when cut. Exterior rated Light Tape® must only be cut and sealed in factory.
- Do not make electrical connections when Light Tape® is turned on.
- Do not operate Light Tape® without protective insulating lamination due to risk of shock. Install in dry conditions. Do not cut or expose open ends to moisture.
- Smart Driver™ power supplies are equipped with overload and short circuit protection. If trip occurs during operation, please inspect Light Tape® for damage, and operating voltage is within correct range.
- Do not operate your Smart Driver™ outdoors unless in a suitably rated enclosure. Ensure installation in a dry environment.

Handling:

- Do not step on Light Tape® during installation. Keep Light Tape® off the floor or any rough surfaces during installation.
- Do not pull on the connector and/or Tab when installing or removing.
- Only install in dry conditions. Do not cut or expose open ends to moisture.
- Take care to not damage lamination when installing around sharp edges or corners. Avoid the use of any sharp objects to force lamp into tight areas.
- Avoid any hard creases. Do not fold, twist, rotate, or kink lamination excessively.
- Do not stretch, puncture, or hard crease Light Tape® in a tight radius, as this will destroy conductive layers causing black spots or failure.
- Do not operate lamp outdoors during peak daylight hours for extended periods as it may be damaged by UV rays.
- Do not thermoform or stretch Light Tape® over objects.
- When cleaning Light Tape® or Smart Driver™, do not use water or chemical cleaners.
- Do not staple or puncture through Light Tape® or the protective lamination. Take care around screw heads or other sharp protruding objects.

General Installation Guidelines:

- Follow all installation guidelines from Electro-LuminX. Please visit our website www.lighttape.com for additional information.
- Please read all instructions prior to installation. Contact your regions tech support with any questions.
- When unpacking, please review all contents on the packing list and immediately notify us of any missing or damaged items.
- There is a front and back of Light Tape®. The gray colored side with a white line down the middle is the back, and non-illuminating side.
- Do not mount using an epoxy, silicone, or other exothermic curing adhesives, as they may damage the conductive layers. We recommend 3M double sided tapes. Please contact us for additional information.
- If mounting near a wet area, please provide suitable protection from pooling water. Ensure there are no standing water conditions, and provisions for drainage are made.
- Light Tape® can be mounted outdoors, however should not be operated in direct sunlight. This will shorten the life of the lamp. Use a photo-cell to prevent the Light Tape® from operating in peak daylight hours.
- Always mount in extrusion or approved system for outdoor installations. It is important to allow for the thermal expansion coefficients of exterior surfaces. Both sides of Light Tape® must remain free to move with changing ambient temperatures.
- Do not mount Light Tape® or Smart Driver™ directly to resonant surfaces such as metal, as this may produce amplified harmonics. We recommend mounting to a cork, or foam layer completely covering the subsurface.
- Light Tape® is non-polar, each hemisphere requires its own lead from the power supply. Multiple Light Tape® pieces must be installed in parallel.
- The Smart Driver™ to be selected based on total load. One Smart Driver™ can light multiple Light Tape® pieces. Do not under load or over load the Smart Driver™
- Do not power up the Smart Driver™ without having the proper load applied.
- The Smart Driver™ should be set to 270V AC output. This will help maximize lifetime of the lamp.
- Always mount the Smart Driver™ vertically (with the fan facing up) if the model has a fan to allow proper air circulation.
- Always store electronics in dust free environments to ensure proper performance.

Backlighting Materials: Top View

BASIC BAR, COUNTER TOP OR WALL

Any surface area can be evenly illuminated with a minimal number of panels and connections. A bar design resembling the one below would require only two Light Tape® panels and one power supply. The Light Tape® panel is placed directly on surface with double sided adhesive.

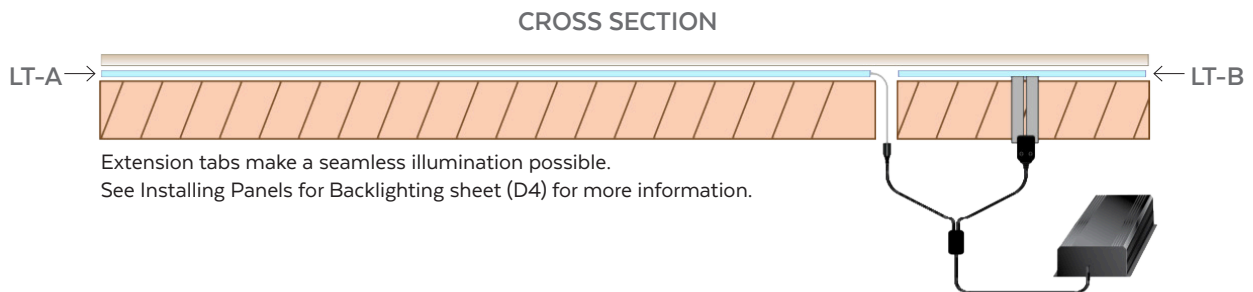
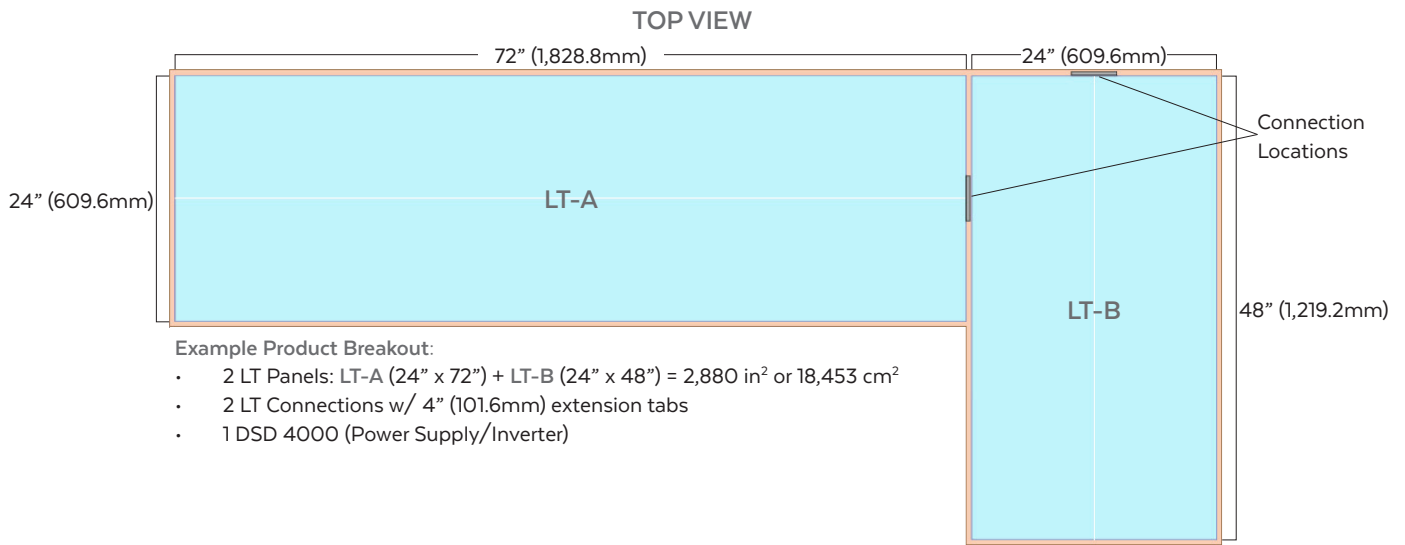

SURFACE WITH CUT OUTS

Light Tape® panels can be custom cut to any shape and placed side-by-side or overlapped to seamlessly illuminate any surface. For custom shapes, an AI file or template will need to be provided.

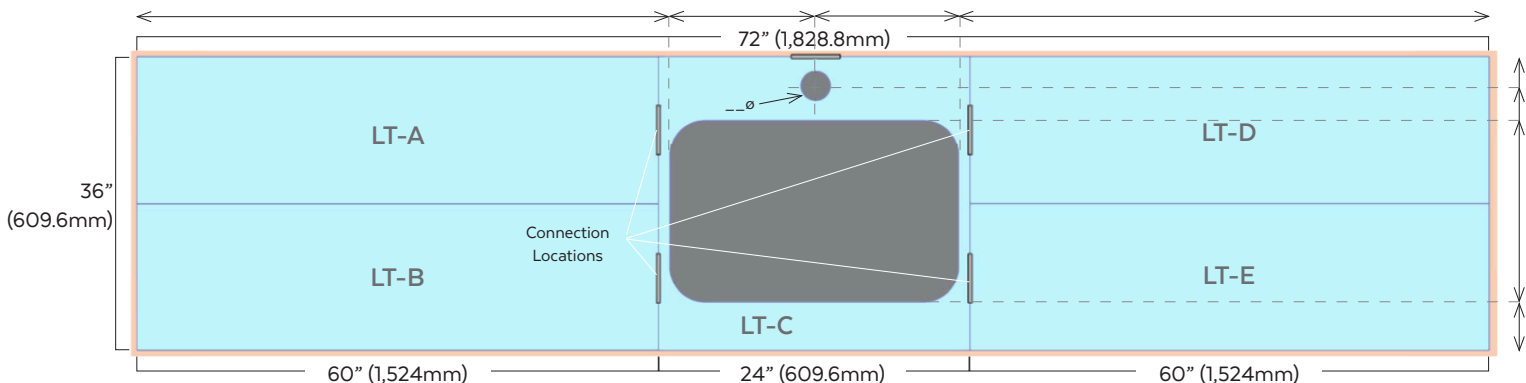

Example Product Breakout:

- 4 LT Panels: LT-A, LT-B, LT-C, LT-D (4)(18"x 60") = 4,320 in² or 27,871 cm²
- 1 LT Custom Panel LT-C (24"x 36") - (12"x24" cutout) = 576 in² or 3,716cm²
- 5 LT Connections w/ 4" (101.6mm) extension tabs
- 1 SD 8000 (total 4,896 in²)

Please note: accurate dimensions for cutouts are required for all custom cut panels

Backlighting Custom Shapes

Light Tape® can be cut into just about any shape and size whilst maintaining its uniform illumination.

No shape is impossible to illuminate, regardless of the size. This makes Light Tape® the most versatile lamp in the world, suitable for any kind of bespoke design.

SYMMETRICAL SHAPES

Both hemispheres need to be equal in surface area to ensure that Light Tape® illuminates evenly. Symmetrical shapes such as the one shown are easily produced, with the SEMP (split electrode midpoint) dividing the shape into two equal hemispheres.

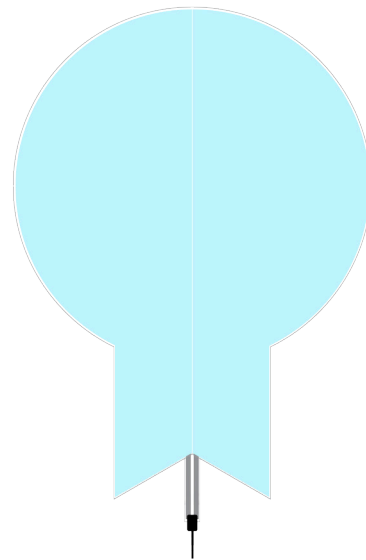

ASYMMETRICAL SHAPES

Creating a custom shaped light source would usually be a daunting process, but with Light Tape®, bespoke lighting has never been easier. For Asymmetrical shapes, we require an Adobe illustrator or PDF file to be submitted with your design. From this file, we can determine the total surface area of your shape and place the SEMP so that the shape is divided into two equal hemispheres.

If you do not have an AI file for your shape, it is possible for our team to create one for you. In this case, simply provide a template of your shape, and we can do the rest.

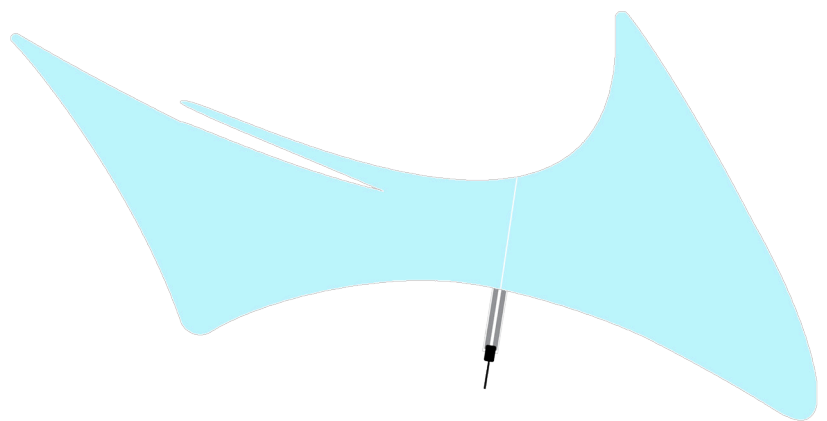

Indoor Installation Tips



1. Clean surface with isopropyl alcohol to remove all dust, oil and grease. Surface should be smooth and clean for strong adhesion.
2. Determine where you will make the electrical connection. It is important to consider the connector and cap lengths. The conductive electrodes can be located behind the Light Tape®. We recommend all electrical connections are made in a suitably rated junction box. Always consult local electrical codes for wiring regulations and installation requirements.
3. Mount in a manner that allows the Light Tape® to be easily serviced (i.e. wall studs behind sheet rock wall). Do not step on Light Tape® during installation. Avoid hard creases. We recommend using our VibraMount™ adhesive as a backing when indoors. Place adhesive on wall, trim to size if needed, and remove liner.
4. Hide the connector. The conductive electrodes are essentially flat conductors. Be care not to rip the surrounding lamination around the lamp; lamination can be trimmed around the tabs if needed. Ensure a sufficient lamination border surrounding the connection tabs.
5. Be very careful when applying Light Tape®, make sure the coiled lamp is straight before you start to unroll. Once it has been applied, pulling Light Tape® off without care may damage the lamp.

Please note:

For larger panels, it is easier to unroll the Light Tape® into place. Begin with the connector end, make sure the leading edge is square, and slowly unroll the panel into position.

Remote Power Supply Installation

Sometimes, the power supply must be located far from the lamps. In this case, shielded conduit may be required to protect against high frequency and high voltage.

- A suitably rated enclosure is required to store power supply when located outdoors to ensure protection against the elements.
- 50 foot connection radius - it is possible to install the Light Tape® up to 50 feet (15.25m) from the Smart Driver™ Power Supply. Multiple connections are possible from one central location.
- Electrical Metallic Tubing (EMT) conduit is required to shield the high voltage and high frequency AC signals for remote installations. All wiring should be within a conduit and 600 volt rated.
- Always consult local electrical codes for wiring regulations and installation requirements.

Installing Panels for Backlighting

It is important to consider the following when installing large panels for backlighting

- Light Tape® panels utilized for backlighting are equipped with extension tabs. The tabs are designed to position the electrical connection under the mounting surface.
- Light Tape® panels do not have polarity (+ or -)
- Multiple panels, connected in parallel, can be powered by a single Smart Driver™ lighting ballast.
- Do not crease or hard fold Light Tape®, keep out of work area until ready to install. Ensure it is placed on a clean, smooth surface.
- Plan panel placement before adhering to surface with foam adhesive panels.
- Do not mount Light Tape® or Smart Driver™ directly to resonant surfaces such as metal, as this may produce amplified harmonics. Please note, audible harmonics will be minimised once Light Tape is secured and installation is complete.
- In many cases, very little adhesive is necessary to hold light tape® in position. Please note, LightTape® is designed for compressive loading only, tensional and shear loads must be avoided.

1. To test the backlighting layout, lay the Light Tape® panels on the surface of the substructure. Adjust the placement of the Light Tape® panels to make sure the entire surface area is covered and there are no seams. It is acceptable for the Light Tape® panels to overlap if necessary, to maintain light uniformity.
2. Once preliminary test layout is complete, identify the position of any clearance cutouts required to conceal the connector into the substructure. Then remove all Light Tape® panels prior to creating the cutout/s.
3. Remove release paper from one side of the foam adhesive and adhere into place on the subsurface.
4. Feed the connectors and leads through the cutouts and connect all leads in parallel to the Smart Driver™ power supply. The Light Tape® panels utilized for backlighting are equipped with flexible extension tabs to allow for concealed connections.
5. Peel off release paper from the other side of the foam adhesive.
6. Making sure to replicate preliminary layout, begin to mount the Light Tape® panels. Starting with connector end, unroll panel in a straight path being careful to avoid bumps or ridges, ensuring the Light Tape® is flat to the surface.
7. Once first panel is set in place, continue placing panels one by one until surface is covered, overlapping adjoining panels to cover entire surface area.
8. Test operation of the Light Tape® panels once all are installed and connected to corresponding power supplies prior to installation of the final backlit surface.

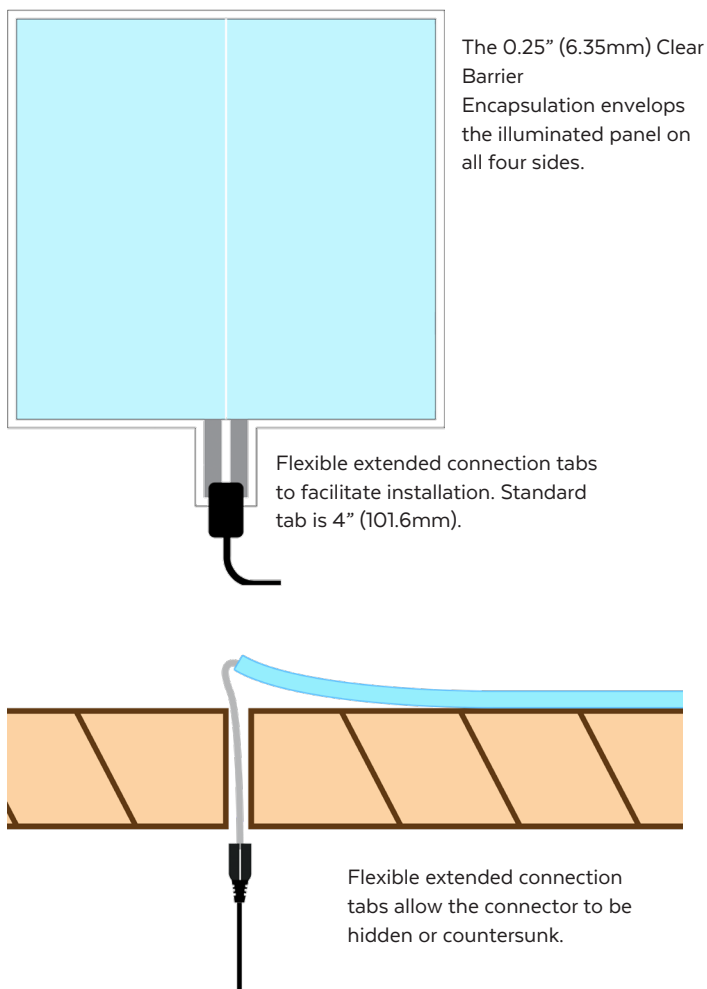

WWW.LIGHTTAPE.COM